

1 2 3 4 5 6

A

B

C

D

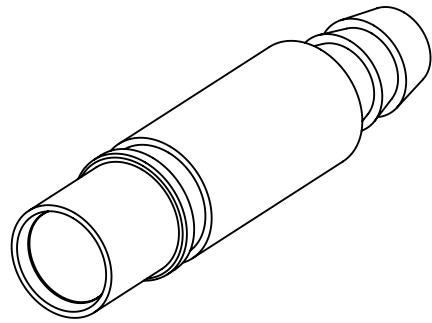
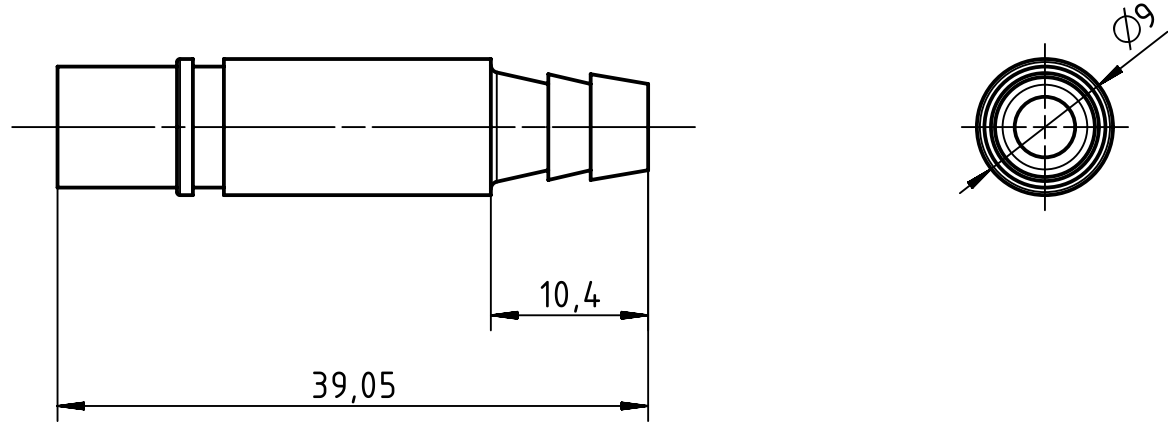

	All rights reserved Department EL PD - DE	All Dimensions in mm Original Size DIN A4		Scale 2:1	Free size tol.		Ref.	
		HARTING Electric GmbH & Co. KG D-32339 Espelkamp		Created by MOELLERLI	Inspected by BEISCHER	Standardisation RUETERA	Date 2018-05-16	State Final Release
Title Pneum. contact metal ID 6 female							Doc-Key / ECM-Nr. 100655197/UGD/001/E 500000133860	
Type TB				Number 09 14 000 6406			Rev. E	Page 1/1