

THIS DRAWING IS UNPUBLISHED. RELEASED FOR PUBLICATION .19  
 © COPYRIGHT 19 BY AMP INCORPORATED. ALL RIGHTS RESERVED.

LOC		DIST		REVISIONS			
P	LTR	DESCRIPTION	DATE	DWN	APVD		
CM	52	F		REVISED PER EC 063B-0104-99	05-OCT-99	KW	KC

- MATES WITH HOUSING 640509.
- UL LOGO AND CSA LOGO TO APPEAR ON EITHER LATCH SURFACE PER AMP SPEC 202-20, I.D. NO. 1-18838-3 AND 1-18839-3. FROST BACKGROUND OPTIONAL.
- DIMENSIONS IN BRACKETS ARE IN INCHES.
- NON-FILL PERMITTED UP TO 3.8[.15] FROM EDGE OF LATCH ARM ON THE 0.38[.015] THICK FLANGE, 4 PLC.

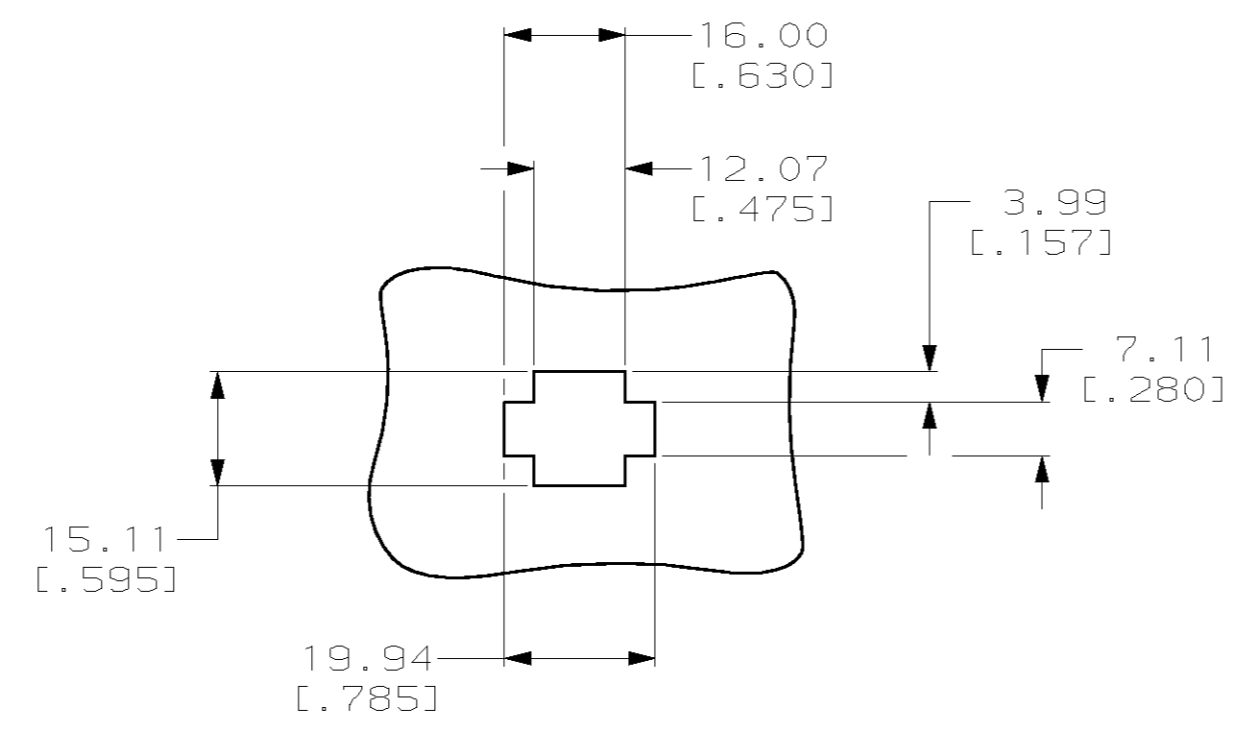
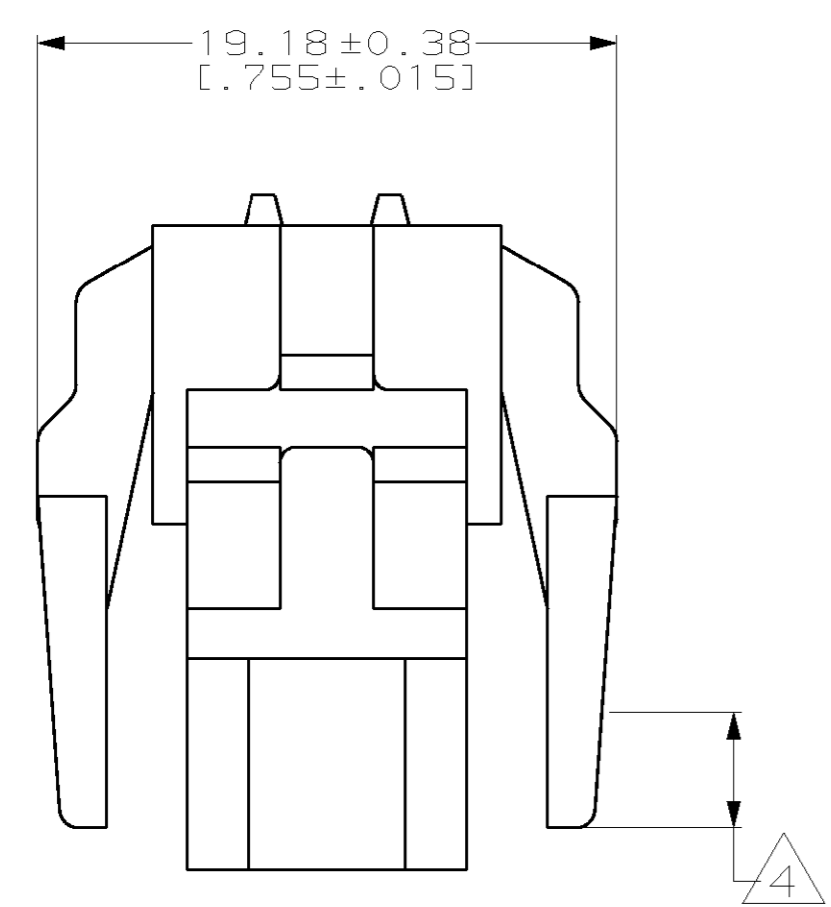
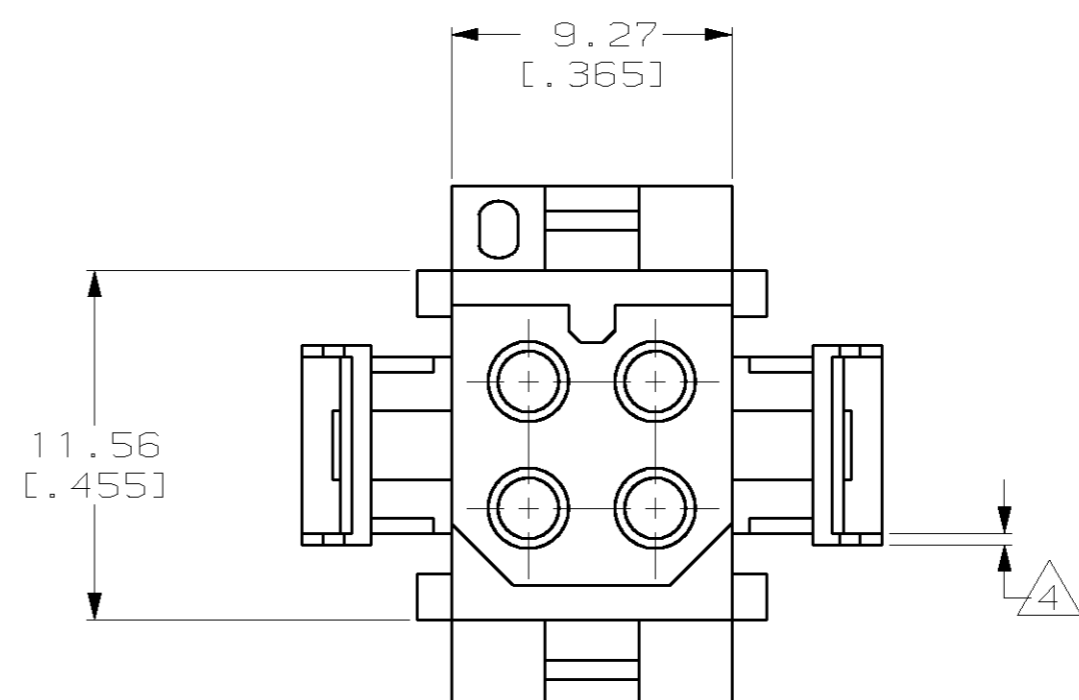
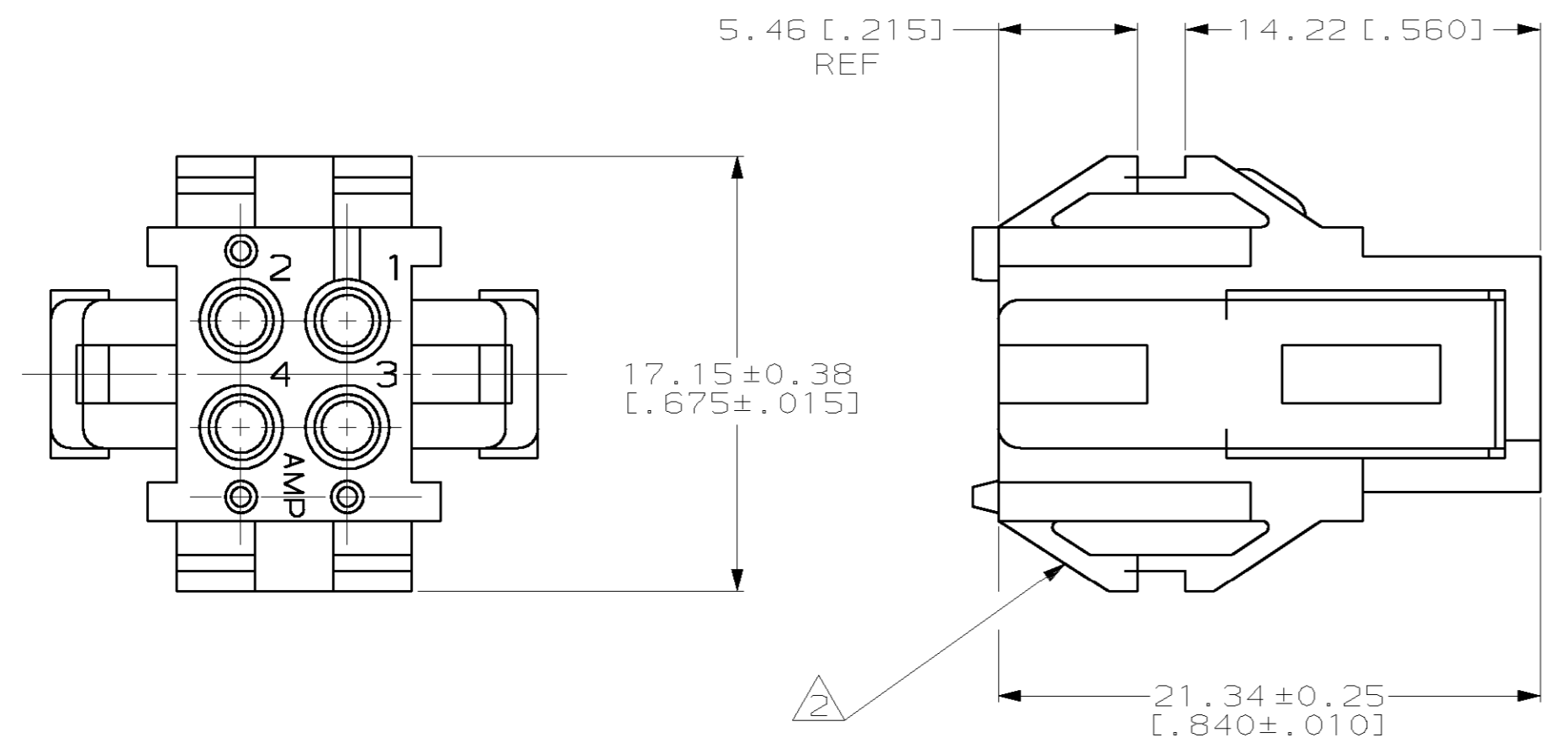

RECOMMENDED CUT OUT FOR 1.73[.068] MAX THICK PANEL  
 SCALE 1:1

1-640519-0  
 PART NUMBER



THIS DRAWING IS A CONTROLLED DOCUMENT.		DWN	R. VESTAL	12-01-97	AMP Incorporated Harrisburg, PA 17105-3608	
DIMENSIONS: mm [INCHES]		CHK	R. SWING	12-01-97		
TOLERANCES UNLESS OTHERWISE SPECIFIED:		APVD	A. BEDDICK	12-01-97		
0 PLC ±- 1 PLC ±- 2 PLC ±0.13[.005] 3 PLC ±- 4 PLC ±- ANGLES ±0°30'		PRODUCT SPEC	NAME			HOUSING, PLUG MRII 4 POSITION
MATERIAL NYLON, UL 94V-0, NATURAL (BRICK RED)		FINISH	-		SIZE	A2
CUSTOMER DRAWING		SCALE	4:1		CAGE CODE	00779
		DRAWING NO	C-640519		SHEET	1 OF 1
		REV	F			