

4

3

2

1

THIS DRAWING IS UNPUBLISHED.

RELEASED FOR PUBLICATION

20

© COPYRIGHT 20 BY -

ALL RIGHTS RESERVED.

REVISIONS

P	LTR	DESCRIPTION	DATE	DWN	APVD
A		INITIAL RELEASE	14APR2015	GY	CW
B		ECR-15-013759	28SEP2015	DW	CW
B1		ECR-16-011988	26AUG2016	YC	CW
B2		ECR-16-017834	21DEC2016	YC	CW

PANEL CUT FOR INSERTS FOR USE
WITHOUT HOODS/ HOUSINGS

不使用防护外壳时芯件的安装开孔图

M4 SCREW, RECOMMENDED
TIGHTENING TORQUE 1.2Nm
M4螺丝, 推荐锁紧力矩1.2Nm

16X M3 SCREW, RECOMMENDED TIGHTENING TORQUE 0.5Nm
16X M3螺丝, 推荐锁紧力矩0.5Nm

4X M3 SCREW, RECOMMENDED TIGHTENING TORQUE 0.5Nm
4X M3螺丝, 推荐锁紧力矩0.5Nm

TYPE 1, T2040162101-000, TE LOGO
类型 1, T2040162101-000, TE LOGO

NOTES:

1. TECHNICAL CHARACTERISTICS:
INSULATION MATERIAL: PC
RATED VOLTAGE: 500V
RATED CURRENT: 16A
INSULATION RESISTANCE: $\geq 400M\Omega$
RATED IMPULSE VOLTAGE: 6KV
POLLUTION DEGREE: 3
FLAMMABILITY: UL94V-0
MATING CYCLES: 500 CYCLES
WIRE RANGE: $0.5mm^2 \sim 2.5mm^2$ (AWG20-AWG14)
CONTACT TYPE: SCREW CLAMP (M3)

注释:

1. 技术参数:
绝缘材料: PC
额定电压: 500V
额定电流: 16A
绝缘电阻: $\geq 400M\Omega$
脉冲电压: 6KV
污染等级: 3
阻燃等级: UL94V-0
插拔次数: 500 次
接线范围: $0.5mm^2 \sim 2.5mm^2$ (AWG20-AWG14)
接线类型: 螺丝压接 (M3)

THIS DRAWING IS A CONTROLLED DOCUMENT.		DWN	GINO YAO	14APR2015	 TE Connectivity
DIMENSIONS:		CHK	CHRIS WANG	14APR2015	
mm		APVD	XIANG XU	14APR2015	
TOLERANCES UNLESS OTHERWISE SPECIFIED:		PRODUCT SPEC	NAME		
0 PLC \pm		APPLICATION SPEC	SIZE		A3
1 PLC \pm		WEIGHT	CAGE CODE		00779
2 PLC \pm		CUSTOMER DRAWING	DRAWING NO		T2040162101000
3 PLC \pm		SCALE	RESTRICTED TO		-
4 PLC \pm		SCALE	SHEET		1 OF 2
ANGLES \pm		SCALE	REV		B2
FINISH					

1470-19 (3/13)

REVISIONS

P	LTR	DESCRIPTION	DATE	DWN	APVD
-		SEE SHEET 1	-	-	-

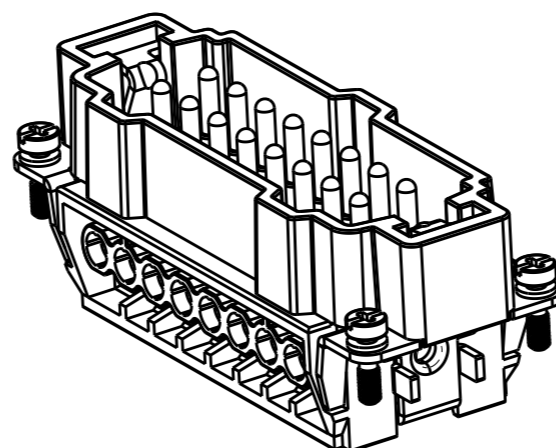
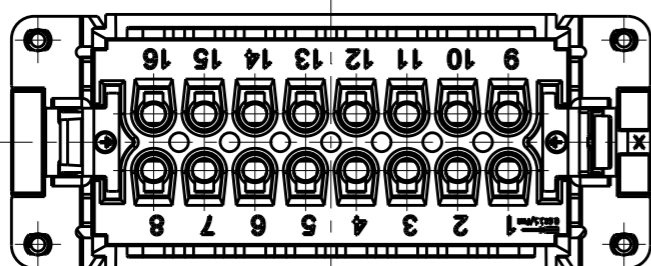

NOTE:
ALL SPEC REFER TO TYPE 1

注释:
所有产品规范参照 TYPE 1

TYPE 2, T2040162101-001, NO LOGO
类型 2, T2040162101-001, 无LOGO

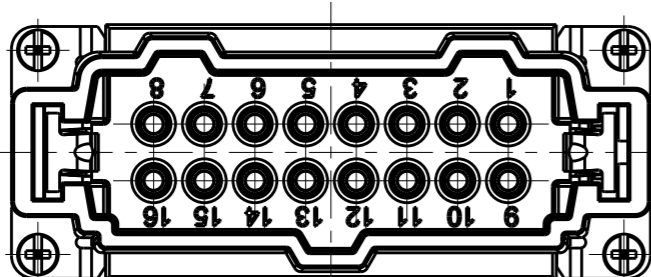
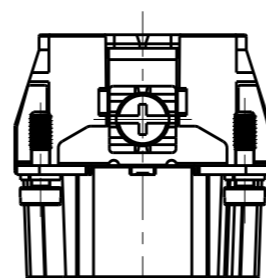
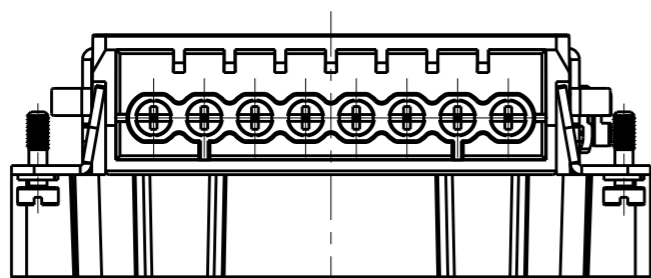

T2040162101-000	HE-016-M	HE-016 MALE INSERT HE-016 公插	TYPE 1
T2040162101-001	HE-016-M	HE-016 MALE INSERT, NO LOGO HE-016 公插, 无LOGO	TYPE 2
PART NUMBER 料号	PART DESCRIPTION 描述		TYPE 类型

THIS DRAWING IS A CONTROLLED DOCUMENT.

DIMENSIONS:
mm

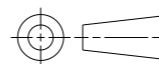

TOLERANCES UNLESS OTHERWISE SPECIFIED:

- 0 PLC ±-
- 1 PLC ±-
- 2 PLC ±-
- 3 PLC ±-
- 4 PLC ±-
- ANGLES ±-

MATERIAL

FINISH

DWN 14APR2015

GINO YAO

CHK 14APR2015

CHRIS WANG

APVD 14APR2015

XIANG XU

PRODUCT SPEC

108-137044

APPLICATION SPEC

114-137044

WEIGHT

-

CUSTOMER DRAWING



TE Connectivity

NAME
HE-016-M

SIZE CAGE CODE DRAWING NO RESTRICTED TO

A3 00779 C-T2040162101000

SCALE 1:1 SHEET 2 OF 2 REV B2